



FengHua
Industry

Calligraphy and painting mounting table design scheme



Design reason

In the special repair process, the repair personnel need to stand above the table to operate, not only to ensure its operability and safety, but also to take into account flexibility and easy disassembly.

Reason one

Reason two

When restoring large-format calligraphy and painting or other cultural relics, two mounting tables need to be easily assembled together to form a large flat table, which is convenient for restorers to restore the cultural relics. After the end, the two can be easily separated.

During the restoration of cultural relics, in order to facilitate the restoration personnel to clearly observe the ancient books and paintings, it is necessary to uniformly illuminate the back of the ancient books and paintings to clearly illuminate the tiled paintings and calligraphy for restoration inspection or copying.

Reason three

overall design

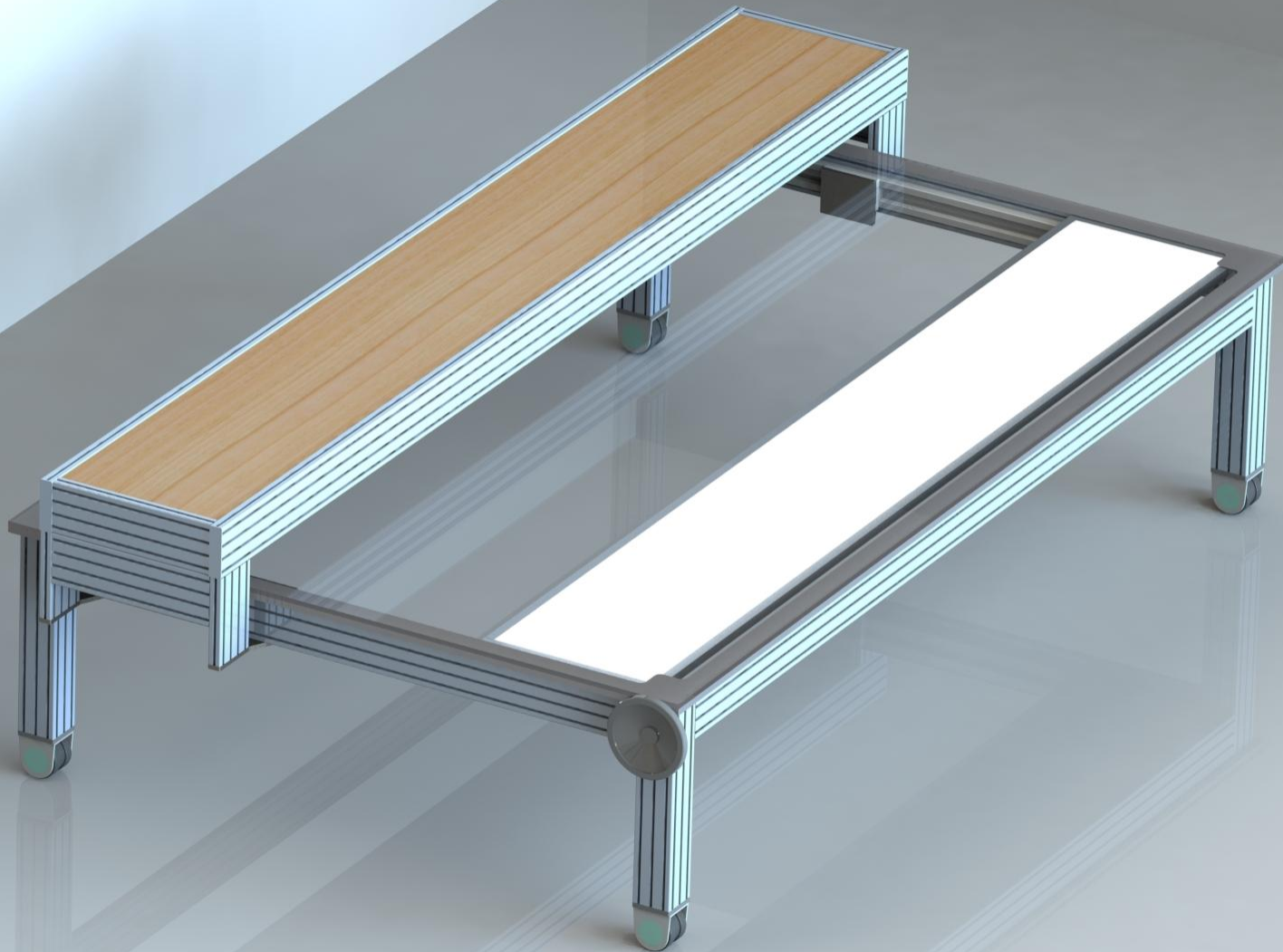

overall design

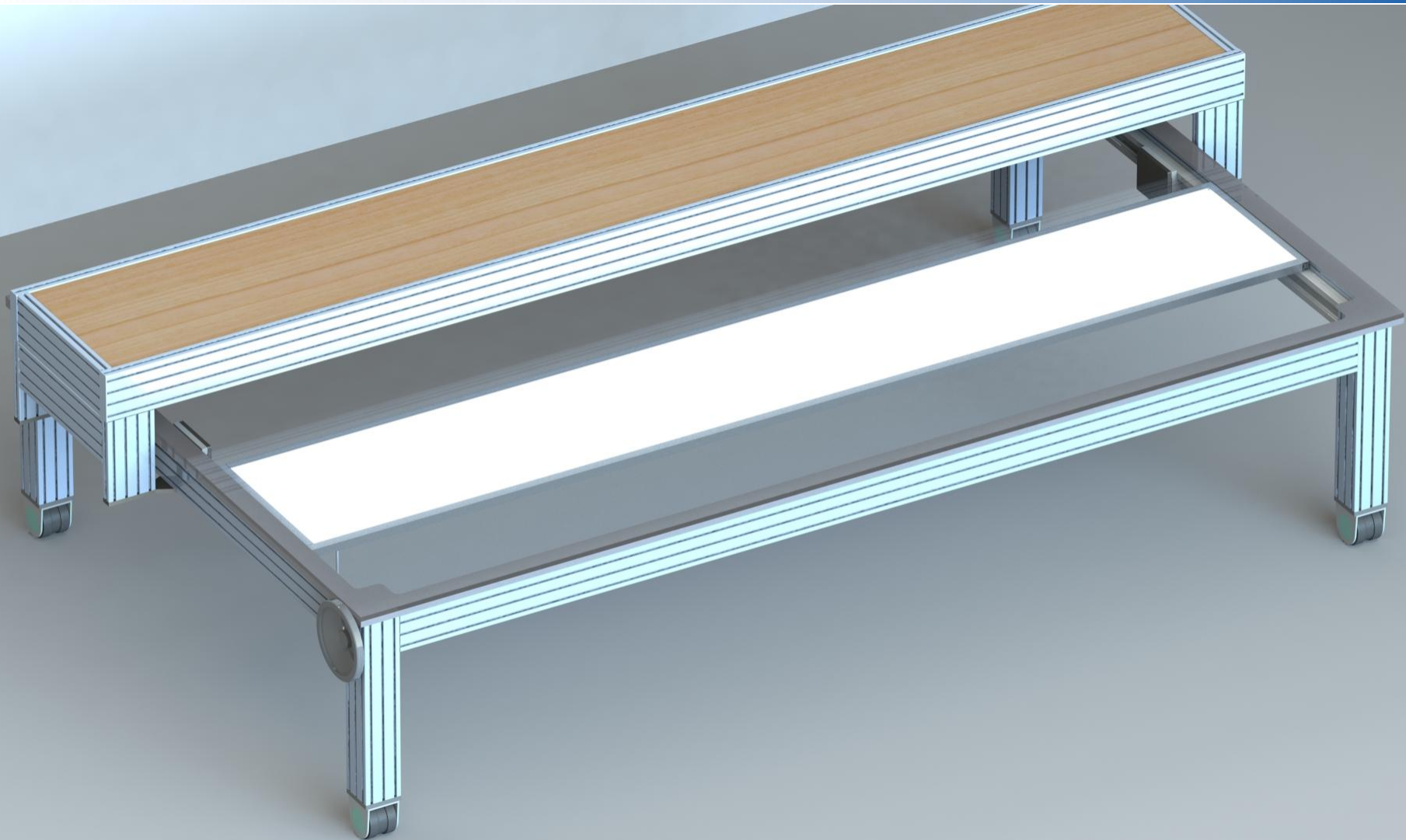

overall design

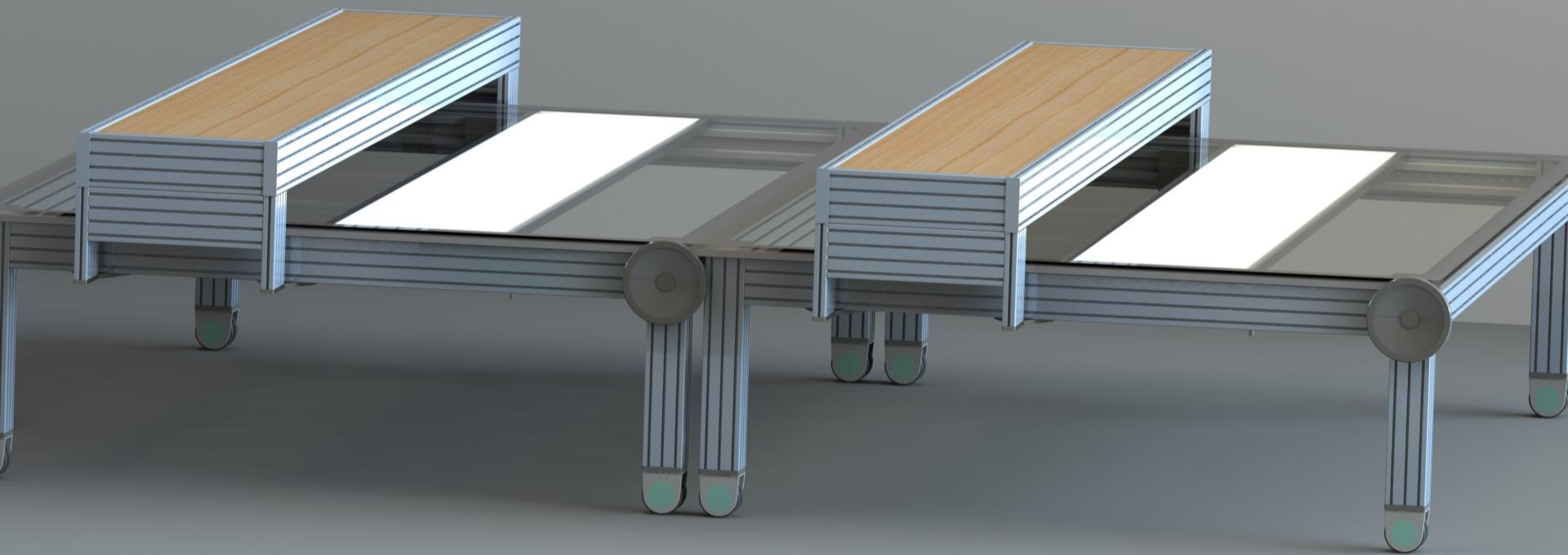

overall design

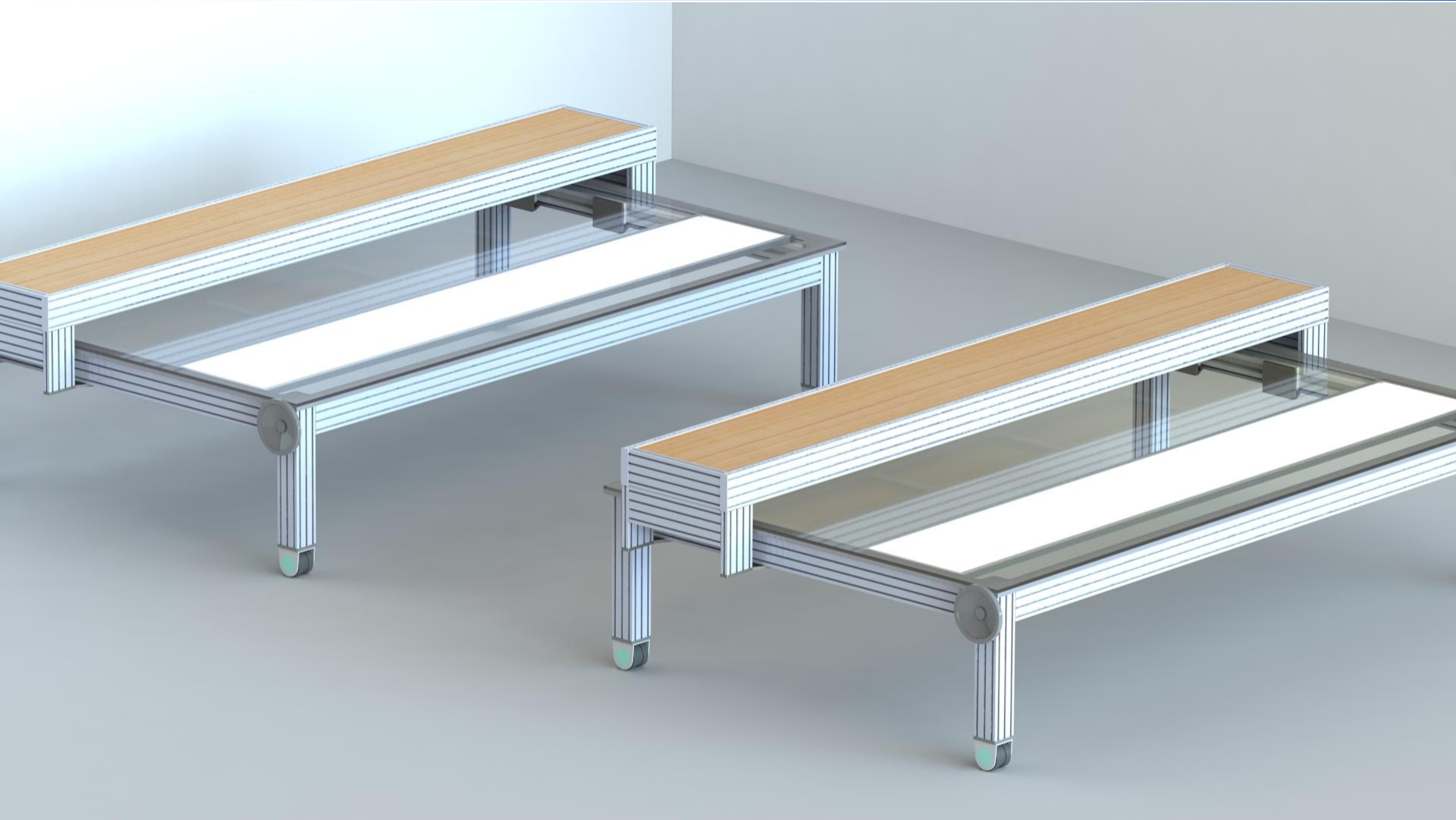

overall design

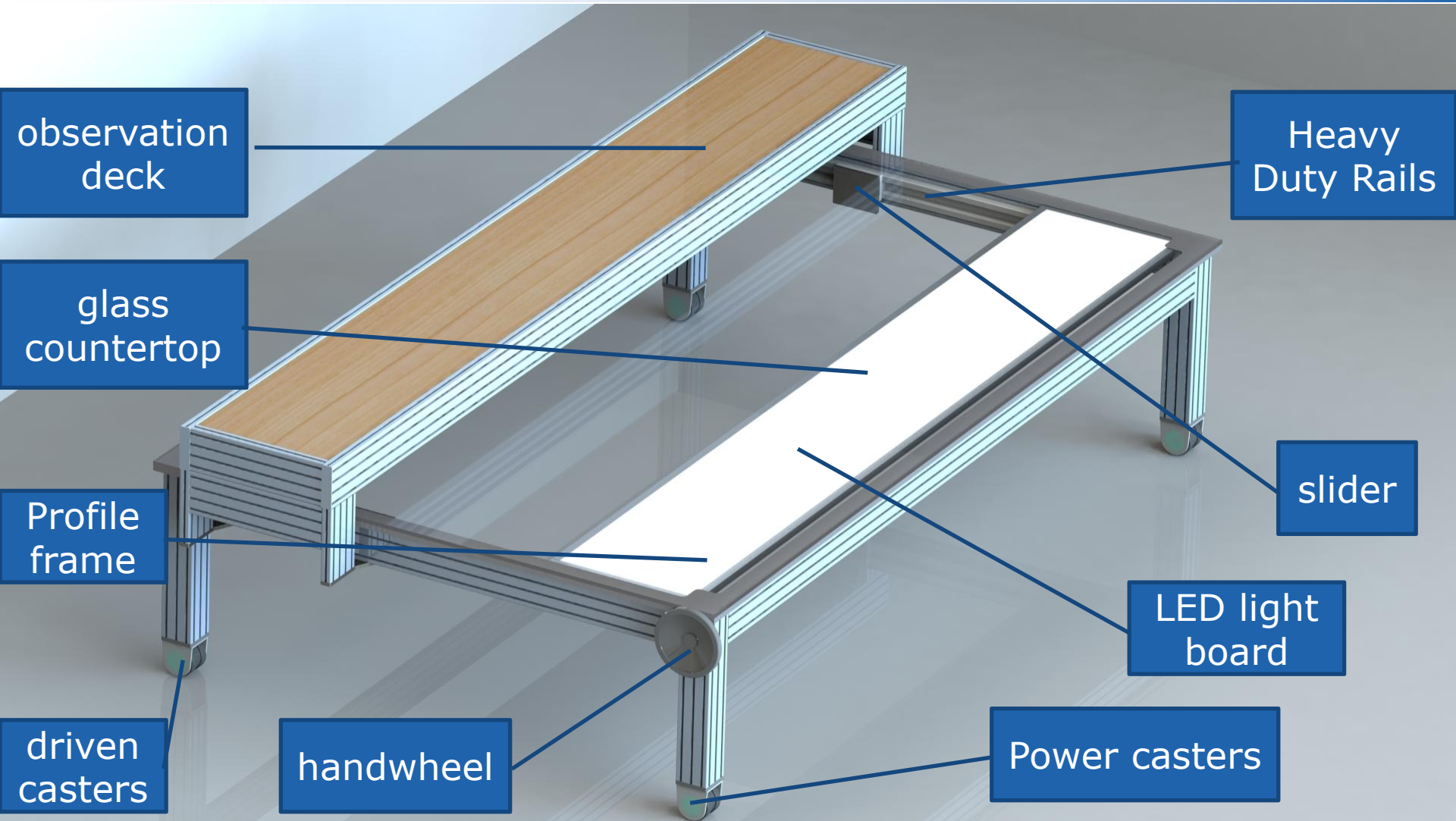

Structure diagram

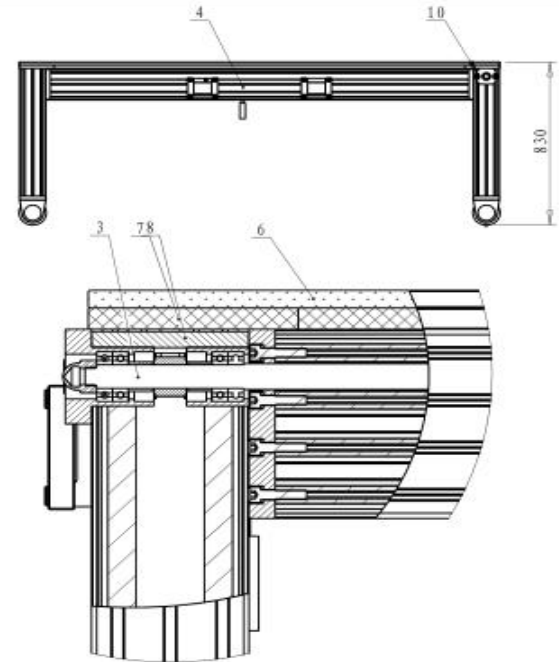
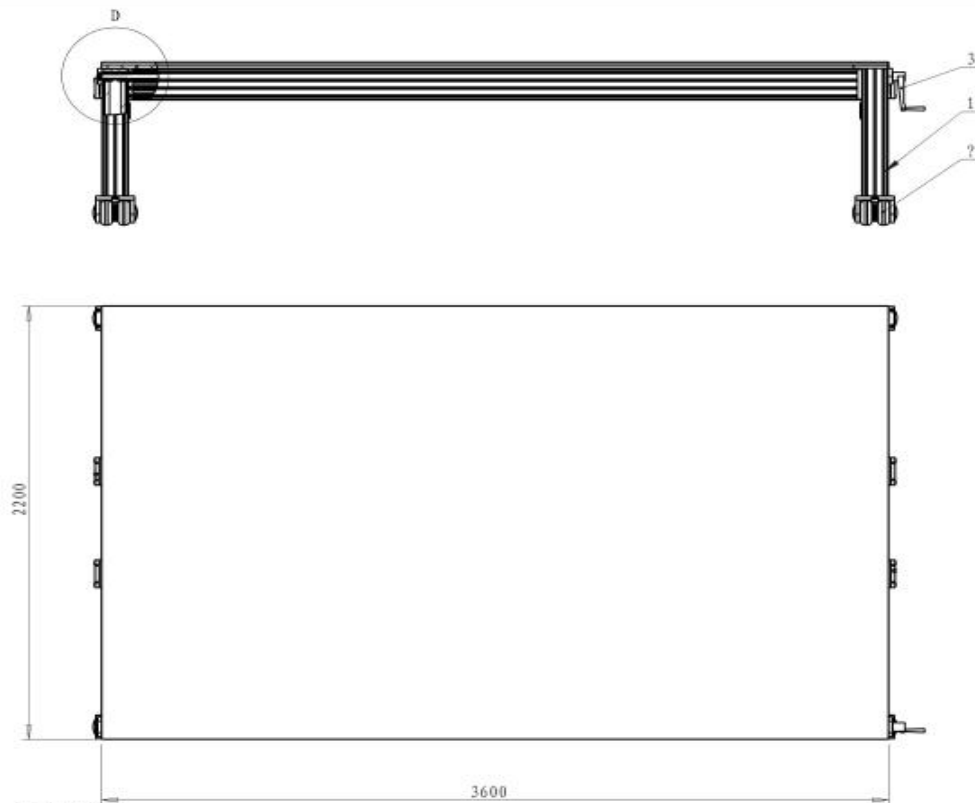

技术要求:

1. 按照图示尺寸及位置关系进行装配;
2. 各零部件安装牢固, 前后移动顺畅;
3. 单台数量: 1件。

序号	图号	名称	数量	材料/规格	备注
14		弹垫 8	8		
13		弹垫 10	4	304钢	
12		方形螺母块 CE-SN8-8-40	8	碳钢	
11		内六角圆柱头螺钉 M10X25	4	304钢	
10		内六角圆柱头螺钉M8X25	8	304钢	
9	XFBT362208-01000004	平板灯	1	LED	
8	XFBT362208-01000003	压板	2	6061-T6	

序号	图号	名称	数量	材料/规格	备注
7	XFBT362208-01000002	垫板	1	橡木	
6	XFBT362208-01000001	钢化玻璃	1	钢化玻璃	3600*2200*15
5	XFBT362208-01050000	自制滑块	2		
4	XFBT362208-01040000	内夹式双轴导轨 SGR35	2	装配体	
3	XFBT362208-01030000	主轴传动装配体	1	装配体	
2		底轮装配体	4		
1	XFBT362208-01010000	檯面台框架装配体	1	装配体	

标记/处数		更改文件号	签字	日期	比例		重量		数量	
设计					1:1					
校对										
审核										
批准										

郑州枫华实业股份有限公司

工作台装配体

XFBT362208-01000000

Technical parameter

1. Dimensions: 3600*2200*830mm, the overall thickness of the table top is 87 ± 2 mm;
2. Countertop: 8+8 high-quality ultra-white tempered laminated glass is used, and the edges and corners are finely ground;
3. The overall frame: it is required to be strong and beautiful; it is made of 6063 aluminum alloy profiles that have undergone T5 aging treatment, and the surface is frosted and silver oxidized; the size of the aluminum profiles is 3600*2200mm;
4. Observation table: The purpose is to facilitate the restoration personnel to stand above the cultural relics to observe and photograph the restoration process, etc., and at the same time, it cannot affect the normal progress of the restoration work, so the external size is set to 3800 × 600mm, and it can be disassembled. Its mechanism is made of aluminum profiles. Frame, wooden table top, structural parts, etc.

Technical parameter

5. Backlight source: LED chip light source, lamp bead type: 24V 2538 lamp bead, color temperature 5500K, adjustable brightness; size 3300*500*70mm, can slide on the guide rail to adjust the light irradiation position; flat lamp can be in the profile groove Slide up to meet the needs of restoration personnel to observe and photograph different areas of textile cultural relics, and the brightness of the lights can be adjusted by remote control。

The main function

With observation deck

The equipment is equipped with a detachable observation platform, on which the restorers can stand on it to observe the ancient books, calligraphy and painting cultural relics in detail, and also facilitate the photographing of the restoration process. The observation table can be moved and locked on the clip-on rails to meet the needs of observation and shooting in different areas.

Equipment can be combined

When faced with the restoration of large cultural relics or work with specific requirements, the restoration personnel can easily combine two or more workbenches into a giant flat table by rotating the handwheel to drive the driving casters, so that the restoration work can be carried out smoothly.

With back light

The table top is made of tempered glass plate, and there is a movable LED flat light source under the table top, which is used as a back lighting source, which can clearly illuminate the tiled calligraphy and paintings, making the restoration process more clear and clear, and can also be used as a copy workbench.

Structure and composition

The structure of the equipment is composed of aluminum profile frame, tempered glass table, observation table, LED light board, guide rail, driving mechanism and so on.

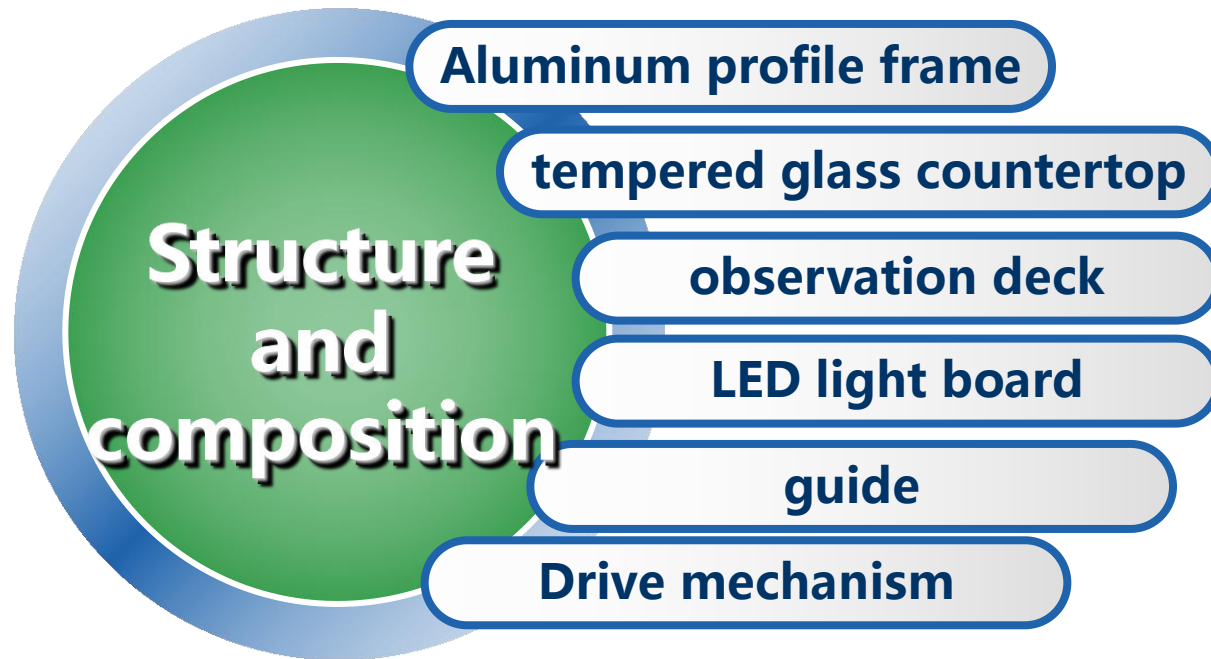

Sales Performance

Palace Museum

Nanjing Museum

Dunhuang Research Institute

Jingzhou Cultural Relics Protection Center